



NEW

HB400



DIE LANGGEZOGENE FORM DIESER LÖFFELS VERHINDERT, DASS ERDE AN DEN SEITENWÄNDEN DES LÖFFELS HAFTET, WAS DEN AUSHUB VON TONIGEM UND FEUCHTEM ERDREICH ERLEICHTERT. ER IST MIT VERSTÄRKUNGEN AUS HB 400 IN DEN HAUPTVERSCHLEISSSTELLEN.

| | MIDI EXCAVATOR | | | | | | | | | | | |
|------|----------------|-----------|-----------|-----------|-----------|-----------|-----------|------------|-------------|-------------|-------------|-------------|
| MOD. | SCS 35HD | SCS 40HD | SCS 48HD | SCS 60HD | SCS 67HD | SCS 71HD | SCS 75HD | SCS 80HD | SCS 85HD | SCS 92HD | SCS 100HD | SCS 110HD |
| TONS | 0,8 - 1,5 | 1,5 - 2,0 | 2,0 - 3,0 | 3,0 - 4,0 | 4,0 - 6,0 | 6,0 - 7,5 | 7,5 - 9,0 | 9,0 - 12,0 | 12,0 - 14,0 | 12,0 - 14,0 | 14,0 - 16,0 | 16,0 - 18,0 |



ADAPTERS

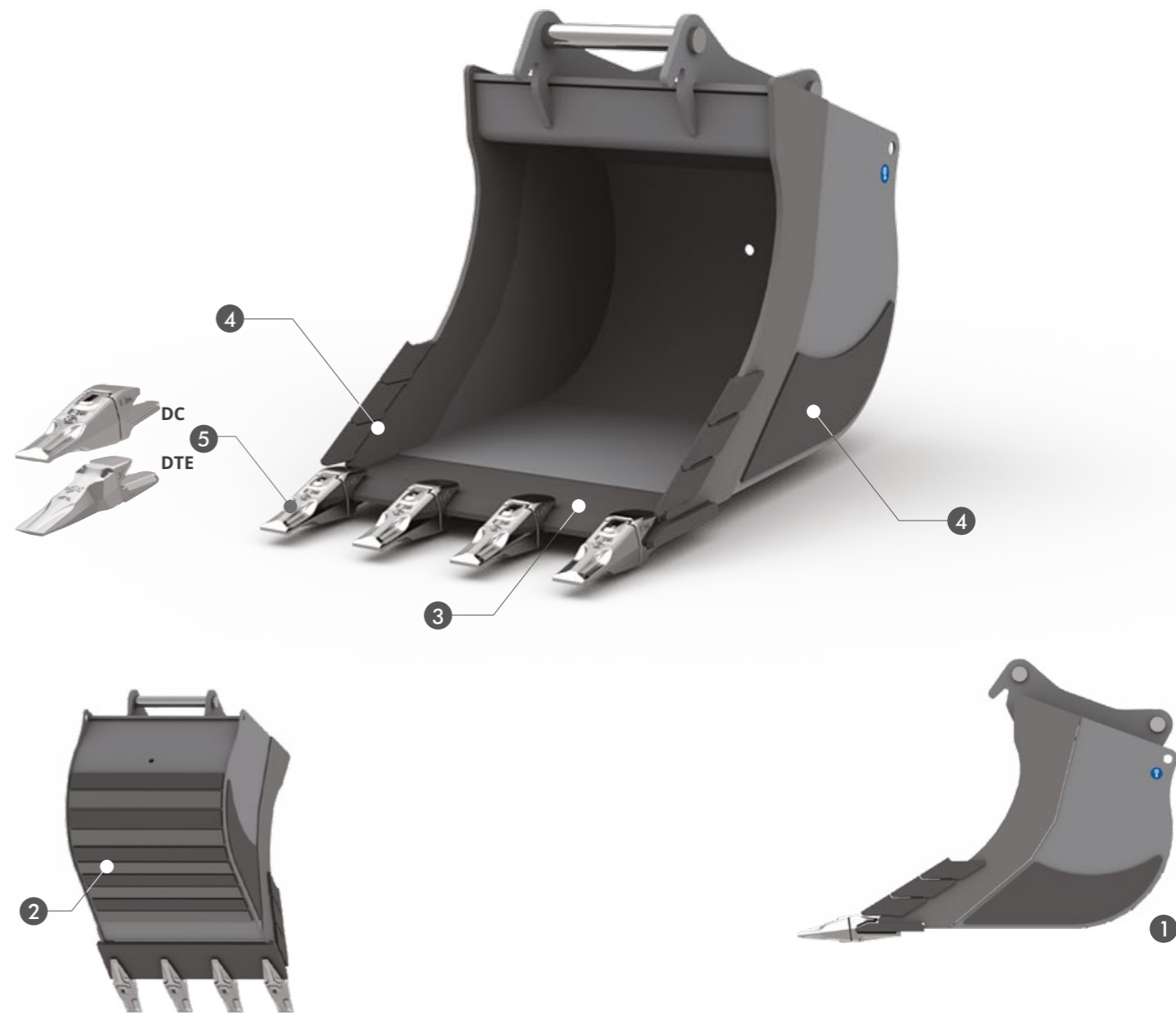

STANDARD TECHNISCHE DATEN

- 1 LANGGEZOGENES PROFIL DOPPELTE**
- 2 VERSTÄRKTER VERSCHLEISS-SCHUTZ HB400**
DIE WAAGERECHTEN VERSTÄRKUNGEN BIETEN OPTIMALEN VERSCHLEISSSCHUTZ UND SCHÜTZEN DIE STRUKTUR.
- 3 SCHNEIDE AUS HB400**
- 4 MESSER-SEITENSCHNEIDEN HB400 SEITENVERSTÄRKUNGEN**
DIE SEITENSCHNEIDEN SIND AUS HB 400. SIE SCHNEIDEN DAS MATERIAL BEIM ERDAUSHUB UND DIENEN ZUSÄTZLICH ALS VERSCHLEISSSCHUTZ.
- 5 ZÄHNE DC ZÄHNE DTE**

SCS35 HD MASCHINENGEWICHT 0,8 - 1,5

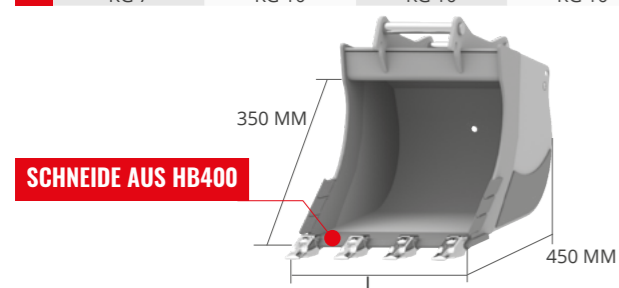

| L MM | GEWICHT KG* | KAP. SAE L | ZÄHNE N° | ADAPTERS |
|---------|----------------|---------------|-------------|-------------------|
| 250 | 20 | 22 | 3 | AF - AR - CS |
| | | | | CR - S - CM |
| | | | | CW - CS JANUS PRO |
| 300 | 24 | 26 | 3 | AF - AR - CS |
| | | | | CR - S - CM |
| | | | | CW - CS JANUS PRO |
| 400 | 30 | 40 | 3 | AF - AR - CS |
| | | | | CR - S - CM |
| | | | | CW - CS JANUS PRO |
| 500 | 35 | 50 | 4 | AF - AR - CS |
| | | | | CR - S - CM |
| | | | | CW - CS JANUS PRO |

SCS48 HD MASCHINENGEWICHT 2,0 - 3,0

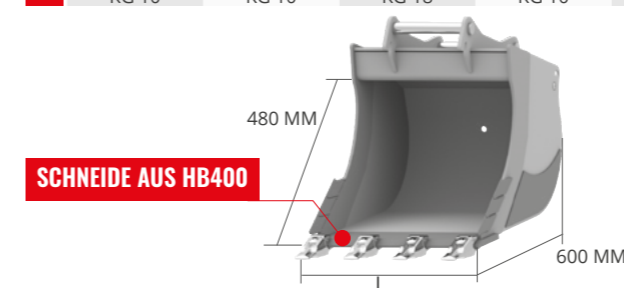

| L MM | GEWICHT KG* | KAP. SAE L | ZÄHNE N° | ADAPTERS |
|---------|----------------|---------------|-------------|-------------------|
| 300 | 38 | 48 | 3 | AF - AR - CS |
| | | | | CR - S - CM |
| | | | | CW - CS JANUS PRO |
| 400 | 48 | 68 | 3 | AF - AR - CS |
| | | | | CR - S - CM |
| | | | | CW - CS JANUS PRO |
| 500 | 61 | 85 | 4 | AF - AR - CS |
| | | | | CR - S - CM |
| | | | | CW - CS JANUS PRO |
| 600 | 72 | 110 | 4 | AF - AR - CS |
| | | | | CR - S - CM |
| | | | | CW - CS JANUS PRO |
| 800 | 98 | 160 | 5 | AF - AR - CS |
| | | | | CR - S - CM |
| | | | | CW - CS JANUS PRO |

SCS40 HD MASCHINENGEWICHT 1,5 - 2,0

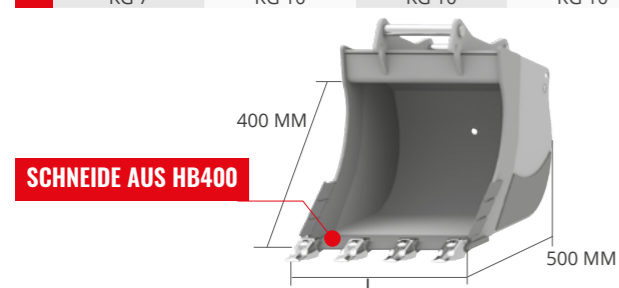

| L MM | GEWICHT KG* | KAP. SAE L | ZÄHNE N° | ADAPTERS |
|---------|----------------|---------------|-------------|-------------------|
| 300 | 26 | 35 | 3 | AF - AR - CS |
| | | | | CR - S - CM |
| | | | | CW - CS JANUS PRO |
| 400 | 34 | 45 | 3 | AF - AR - CS |
| | | | | CR - S - CM |
| | | | | CW - CS JANUS PRO |
| 500 | 42 | 60 | 4 | AF - AR - CS |
| | | | | CR - S - CM |
| | | | | CW - CS JANUS PRO |
| 600 | 49 | 85 | 4 | AF - AR - CS |
| | | | | CR - S - CM |
| | | | | CW - CS JANUS PRO |

SCS60 HD MASCHINENGEWICHT 3,0 - 4,0

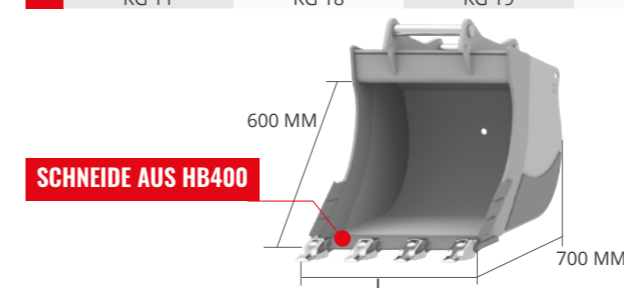

| L MM | GEWICHT KG* | KAP. SAE L | ZÄHNE N° | ADAPTERS |
|---------|----------------|---------------|-------------|-------------------|
| 300 | 52 | 78 | 3 | AF - AR - CS |
| | | | | CR - S - CM |
| | | | | CW - CS JANUS PRO |
| 400 | 63 | 105 | 3 | AF - AR - CS |
| | | | | CR - S - CM |
| | | | | CW - CS JANUS PRO |
| 500 | 76 | 140 | 4 | AF - AR - CS |
| | | | | CR - S - CM |
| | | | | CW - CS JANUS PRO |
| 600 | 91 | 165 | 4 | AF - AR - CS |
| | | | | CR - S - CM |
| | | | | CW - CS JANUS PRO |
| 800 | 112 | 225 | 5 | AF - AR - CS |
| | | | | CR - S - CM |
| | | | | CW - CS JANUS PRO |

* Gewicht des Löffel ohne Anbauteile und Zähne

* Gewicht des Löffel ohne Anbauteile und Zähne

SCS67 HD MASCHINENGEWICHT 4,0 - 6,0

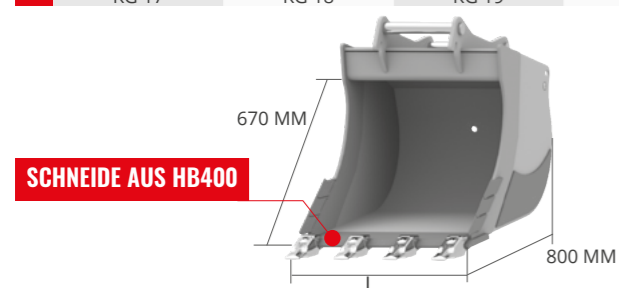

| L MM | GEWICHT KG* | KAP. SAE L | ZÄHNE N° | ADAPTERS |
|---------|----------------|---------------|-------------|--|
| 300 | 75 | 90 | 3 | AF - AR - CS CR - S - CM CW - CS JANUS PRO |
| 400 | 85 | 130 | 3 | AF - AR - CS CR - S - CM CW - CS JANUS PRO |
| 500 | 105 | 170 | 4 | AF - AR - CS CR - S - CM CW - CS JANUS PRO |
| 600 | 122 | 200 | 4 | AF - AR - CS CR - S - CM CW - CS JANUS PRO |
| 800 | 160 | 280 | 5 | AF - AR - CS CR - S - CM CW - CS JANUS PRO |

SCS75 HD MASCHINENGEWICHT 7,5 - 9,0

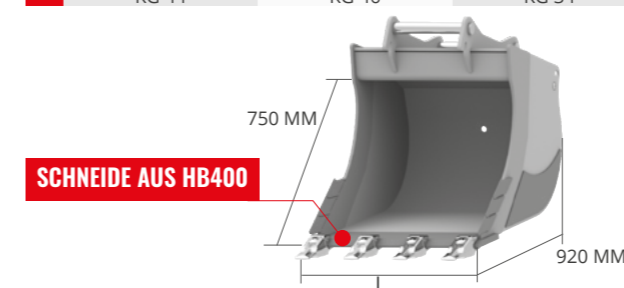

| L MM | GEWICHT KG* | KAP. SAE L | ZÄHNE N° | ADAPTERS |
|---------|----------------|---------------|-------------|---|
| 400 | 123 | 165 | 3 | AF - CS CR - S - CM CW - CS JANUS PRO |
| 500 | 145 | 210 | 4 | AF - CS CR - S - CM CW - CS JANUS PRO |
| 600 | 170 | 260 | 4 | AF - CS CR - S - CM CW - CS JANUS PRO |
| 700 | 198 | 300 | 5 | AF - CS CR - S - CM CW - CS JANUS PRO |
| 800 | 220 | 350 | 5 | AF - CS CR - S - CM CW - CS JANUS PRO |
| 1000 | 263 | 450 | 5 | AF - CS CR - S - CM CW - CS JANUS PRO |

SCS71 HD MASCHINENGEWICHT 6,0 - 7,5

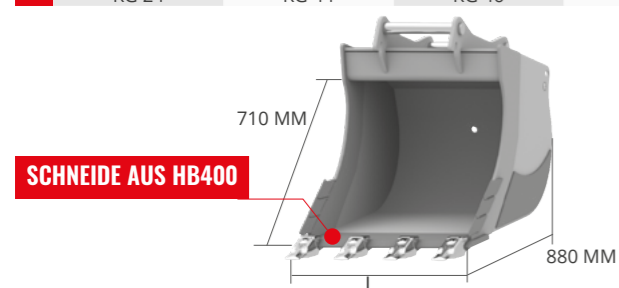

| L MM | GEWICHT KG* | KAP. SAE L | ZÄHNE N° | ADAPTERS |
|---------|----------------|---------------|-------------|--|
| 400 | 108 | 150 | 3 | AF - AR - CS CR - S - CM CW - CS JANUS PRO |
| 500 | 130 | 190 | 4 | AF - AR - CS CR - S - CM CW - CS JANUS PRO |
| 600 | 154 | 230 | 4 | AF - AR - CS CR - S - CM CW - CS JANUS PRO |
| 700 | 176 | 260 | 5 | AF - AR - CS CR - S - CM CW - CS JANUS PRO |
| 800 | 197 | 315 | 5 | AF - AR - CS CR - S - CM CW - CS JANUS PRO |

SCS80 HD MASCHINENGEWICHT 9,0 - 12,0

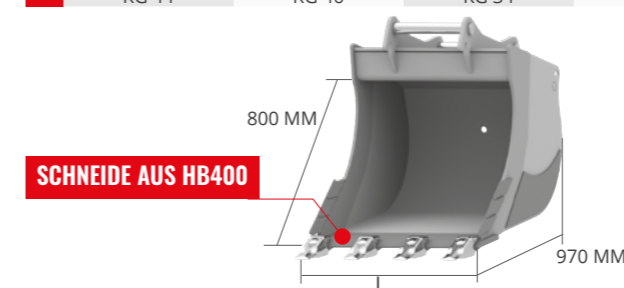

| L MM | GEWICHT KG* | KAP. SAE L | ZÄHNE N° | ADAPTERS |
|---------|----------------|---------------|-------------|---|
| 400 | 133 | 190 | 3 | AF - CS CR - S - CM CW - CS JANUS PRO |
| 500 | 153 | 245 | 3 | AF - CS CR - S - CM CW - CS JANUS PRO |
| 600 | 178 | 300 | 4 | AF - CS CR - S - CM CW - CS JANUS PRO |
| 700 | 209 | 350 | 4 | AF - CS CR - S - CM CW - CS JANUS PRO |
| 800 | 234 | 400 | 5 | AF - CS CR - S - CM CW - CS JANUS PRO |
| 1000 | 283 | 500 | 5 | AF - CS CR - S - CM CW - CS JANUS PRO |

* Gewicht des Löffel ohne Anbauteile und Zähne

* Gewicht des Löffel ohne Anbauteile und Zähne

SCS85 HD MIDI MASCHINENGEWICHT 12,0 - 14,0

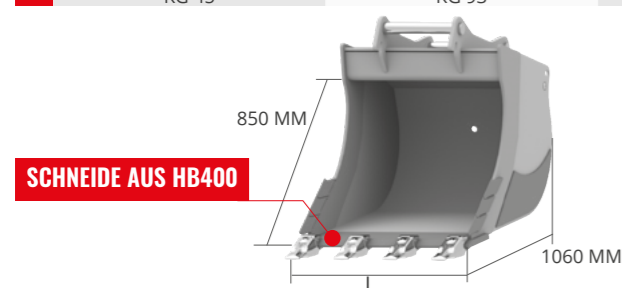

| L MM | GEWICHT KG* | KAP. SAE L | ZÄHNE N° | ADAPTERS |
|---------|----------------|---------------|-------------|--|
| 500 | 197 | 265 | 3 | AF - S - CM CS - CW CS JANUS PRO |
| 600 | 225 | 330 | 4 | AF - S - CM CS - CW CS JANUS PRO |
| 700 | 256 | 400 | 4 | AF - S - CM CS - CW CS JANUS PRO |
| 800 | 284 | 450 | 5 | AF - S - CM CS - CW CS JANUS PRO |
| 900 | 312 | 500 | 5 | AF - S - CM CS - CW CS JANUS PRO |
| 1000 | 342 | 580 | 5 | AF - S - CM CS - CW CS JANUS PRO |
| 1200 | 383 | 740 | 6 | AF - S - CM CS - CW CS JANUS PRO |

SCS100 HD MASCHINENGEWICHT 14,0 - 16,0

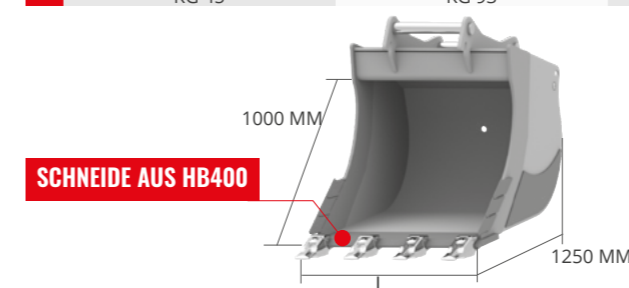

| L MM | GEWICHT KG* | KAP. SAE L | ZÄHNE N° | ADAPTERS |
|---------|----------------|---------------|-------------|--|
| 600 | 353 | 450 | 3 | AF - S - CM CS - CW CS JANUS PRO |
| 700 | 397 | 535 | 4 | AF - S - CM CS - CW CS JANUS PRO |
| 800 | 441 | 620 | 4 | AF - S - CM CS - CW CS JANUS PRO |
| 900 | 485 | 710 | 4 | AF - S - CM CS - CW CS JANUS PRO |
| 1000 | 529 | 800 | 5 | AF - S - CM CS - CW CS JANUS PRO |
| 1200 | 617 | 980 | 5 | AF - S - CM CS - CW CS JANUS PRO |

SCS92 HD EXCAVATOR MASCHINENGEWICHT 12,0 - 14,0

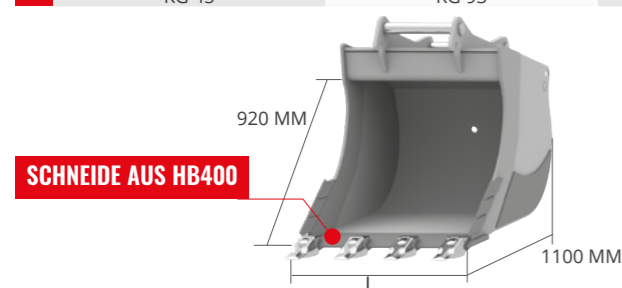

| L MM | GEWICHT KG* | KAP. SAE L | ZÄHNE N° | ADAPTERS |
|---------|----------------|---------------|-------------|--|
| 600 | 261 | 380 | 4 | AF - S - CM CS - CW CS JANUS PRO |
| 700 | 287 | 450 | 4 | AF - S - CM CS - CW CS JANUS PRO |
| 800 | 320 | 560 | 5 | AF - S - CM CS - CW CS JANUS PRO |
| 900 | 352 | 620 | 5 | AF - S - CM CS - CW CS JANUS PRO |
| 1000 | 395 | 700 | 5 | AF - S - CM CS - CW CS JANUS PRO |
| 1200 | 454 | 900 | 6 | AF - S - CM CS - CW CS JANUS PRO |

* Gewicht des Löffel ohne Anbauteile und Zähne

SCS110 HD MASCHINENGEWICHT 16,0 - 18,0

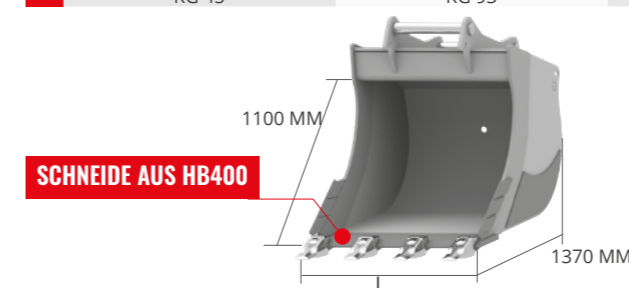

| L MM | GEWICHT KG* | KAP. SAE L | ZÄHNE N° | ADAPTERS |
|---------|----------------|---------------|-------------|--|
| 600 | 457 | 480 | 3 | AF - S - CM CS - CW CS JANUS PRO |
| 800 | 559 | 690 | 4 | AF - S - CM CS - CW CS JANUS PRO |
| 1000 | 671 | 900 | 5 | AF - S - CM CS - CW CS JANUS PRO |
| 1200 | 773 | 1110 | 5 | AF - S - CM CS - CW CS JANUS PRO |
| 1300 | 824 | 1220 | 6 | AF - S - CM CS - CW CS JANUS PRO |
| 1400 | 875 | 1330 | 6 | AF - S - CM CS - CW CS JANUS PRO |

* Gewicht des Löffel ohne Anbauteile und Zähne